

Palonnier fixe Type PALF avec crochets CMU:10t L:2m



Références du produit

Reference: LEV26833

EAN13: -

UPC: -

Description du produit

Caractéristiques

Longueur (m): 2

CMU (kg): 10000

Images

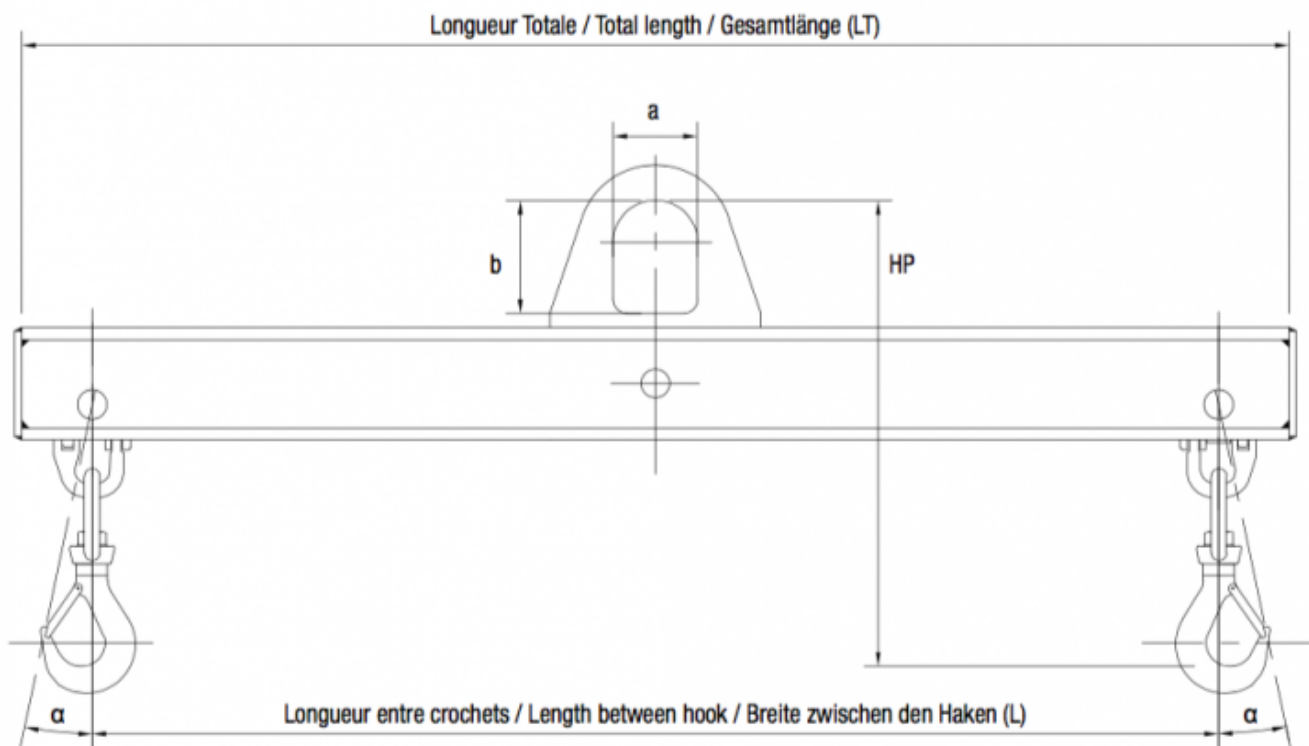



CMU	Longueur entre crochets (L)	Longueur Totale (LT)	Hauteur pendue (HP)	a	b	Poids
Max. capacity	Length between hooks (L)	Total length (LT)	Headroom (HP)			Weight
Tragfähigkeit	Länge zwischen den Haken (L)	Gesamtlänge (LT)	Höhenverlust (HP)			Gewicht
KG	mm	mm	mm	mm	mm	KG
1 000	1 000	1 100	320			32
	2 000	2 100	340			59
	3 000	3 100	360	60	80	96
	4 000	4 100	360			122
	5 000	5 100	380			178
	6 000	6 100	380			208
2 000	1 000	1 100	380			39
	2 000	2 100	400			72
	3 000	3 100	420	80	120	115
	4 000	4 100	440			170
	5 000	5 100	460			240
	6 000	6 100	480			324
3 000	1 000	1 100	480			56
	2 000	2 100	500			94
	3 000	3 100	540	100	180	163
	4 000	4 100	560			234
	5 000	5 100	580			328
	6 000	6 100	600			432
4 000	1 000	1 100	480			82
	2 000	2 100	520			112
	3 000	3 100	560	100	180	190
	4 000	4 100	580			274
	5 000	5 100	600			375
	6 000	6 100	620			495
5 000	1 000	1 100	540			89
	2 000	2 100	580			126
	3 000	3 100	620	100	180	216
	4 000	4 100	640			306
	5 000	5 100	660			420
	6 000	6 100	700			597
6 000	1 000	1 100	540			80
	2 000	2 100	600			151
	3 000	3 100	640	100	180	250
	4 000	4 100	660			355
	5 000	5 100	700			516
	6 000	6 100	700			608
8 000	1 000	1 100	600			83
	2 000	2 100	660			178
	3 000	3 100	700	100	180	288
	4 000	4 100	740			431
	5 000	5 100	740			524
	6 000	6 100	840			616
10 000	1 000	1 100	620			107
	2 000	2 100	680			198
	3 000	3 100	740	100	180	345
	4 000	4 100	740			437
	5 000	5 100	740			530
	6 000	6 100	790			798