

Pied articulé oscillant embase acier diam 50 et tige acier M12 long. 125 charge max 4 000 N



Références du produit

Reference: -

EAN13: -

UPC: -

Description du produit

Pied articulé oscillant. Embase inox diam 50 avec semelle. Tige inox M12 longueur 125, charge max : 4 000 Newton

Caractéristique matière : Embase en inox AISI 304. Tige en inox AISI 304 livrée sans écrou. Semelle en caoutchouc NBR vulcanisé dureté 80° shore.

Info : Excellent rapport performance/coût. Réalisation de dimensions et finitions spéciales de tiges filetées dès 200 pièces. Semelle extrêmement résistante aux ripages ou déplacements de machines. Inox 316 sur demande. Finition sablée sur demande

Les photos ne sont pas contractuelles.

Pour plus d'informations : contact@binder-jenny.fr ou 03 88 39 21 45

Caractéristiques

Filetage (mm): M12

Hauteur totale (mm): 154

Hauteur minimum (mm): 29

Résistance (Newton): 4000

Hauteur base : 19

longueur filetage: 125





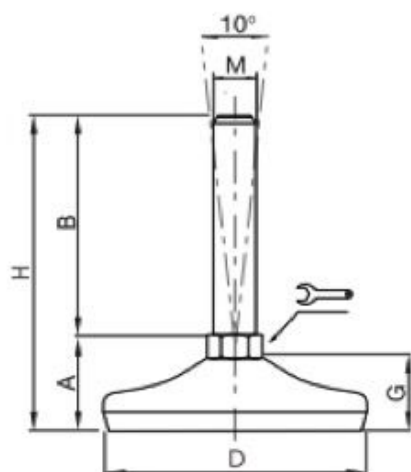











Diamètre de la base : 50

Images



Embases tôle inox

ø 50
**Embasse inox Tige inox
 Pied articulé oscillant**

| DIMENSIONS | | | | | | | CHARGE MAXI |
|------------|-----|----|--|-----|----|-----|-------------|
| A | B | D |  | M | G | H | Newton |
| 29 | 50 | 50 | 14  | M10 | 19 | 79 | 4 000 |
| 29 | 75 | 50 | 14  | M10 | 19 | 104 | 4 000 |
| 29 | 100 | 50 | 14  | M10 | 19 | 129 | 4 000 |
| 29 | 125 | 50 | 14  | M10 | 19 | 154 | 4 000 |
| 29 | 50 | 50 | 14  | M12 | 19 | 79 | 4 000 |
| 29 | 75 | 50 | 14  | M12 | 19 | 104 | 4 000 |
| 29 | 100 | 50 | 14  | M12 | 19 | 129 | 4 000 |
| 29 | 125 | 50 | 14  | M12 | 19 | 154 | 4 000 |
| 29 | 75 | 50 | 14  | M14 | 19 | 104 | 4 000 |
| 29 | 100 | 50 | 14  | M14 | 19 | 129 | 4 000 |
| 29 | 125 | 50 | 14  | M14 | 19 | 154 | 4 000 |
| 29 | 150 | 50 | 14  | M14 | 19 | 179 | 4 000 |
| 34 | 75 | 50 | 13  | M16 | 19 | 109 | 4 000 |
| 34 | 100 | 50 | 13  | M16 | 19 | 134 | 4 000 |
| 34 | 125 | 50 | 13  | M16 | 19 | 159 | 4 000 |
| 34 | 150 | 50 | 13  | M16 | 19 | 184 | 4 000 |

Matière : Embasse en inox AISI. Tige en inox AISI 304 livrée sans écrou.

Semelle en caoutchouc NBR vulcanisé. Dureté 80° shore.

Note : Excellent rapport performance/coût.

Semelle extrêmement résistante aux ripages ou déplacements de machines.