

Pied articulé oscillant embase acier diam 50 et tige acier M12 long. 100 charge max 4 000 N



Références du produit

Reference: -

EAN13: -

UPC: -

Description du produit

Pied articulé oscillant. Embase inox diam 50 avec semelle. Tige inox M12 longueur 100, charge max : 4 000 Newton

Caractéristique matière : Embase en inox AISI 304. Tige en inox AISI 304 livrée sans écrou. Semelle en caoutchouc NBR vulcanisé dureté 80° shore.

Info : Excellent rapport performance/coût. Réalisation de dimensions et finitions spéciales de tiges filetées dès 200 pièces. Semelle extrêmement résistante aux ripages ou déplacements de machines. Inox 316 sur demande. Finition sablée sur demande

Les photos ne sont pas contractuelles.

Pour plus d'informations : contact@binder-jenny.fr ou 03 88 39 21 45



Caractéristiques

Filetage (mm): M12

Hauteur totale (mm): 129

Hauteur minimum (mm): 29

Résistance (Newton): 4000

Hauteur base : 19

longueur filetage: 100





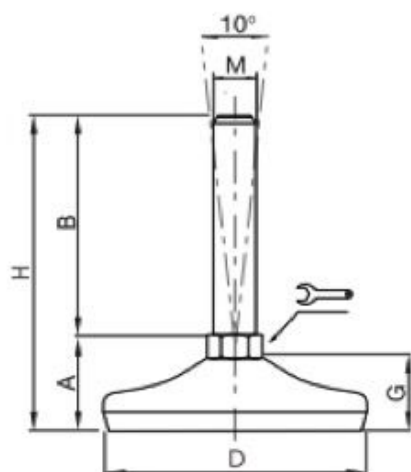











Diamètre de la base : 50

Images



Embases tôle inox

ø 50
**Embasse inox Tige inox
 Pied articulé oscillant**

DIMENSIONS							CHARGE MAXI
A	B	D		M	G	H	Newton
29	50	50	14 	M10	19	79	4 000
29	75	50	14 	M10	19	104	4 000
29	100	50	14 	M10	19	129	4 000
29	125	50	14 	M10	19	154	4 000
29	50	50	14 	M12	19	79	4 000
29	75	50	14 	M12	19	104	4 000
29	100	50	14 	M12	19	129	4 000
29	125	50	14 	M12	19	154	4 000
29	75	50	14 	M14	19	104	4 000
29	100	50	14 	M14	19	129	4 000
29	125	50	14 	M14	19	154	4 000
29	150	50	14 	M14	19	179	4 000
34	75	50	13 	M16	19	109	4 000
34	100	50	13 	M16	19	134	4 000
34	125	50	13 	M16	19	159	4 000
34	150	50	13 	M16	19	184	4 000

Matière : Embasse en inox AISI. Tige en inox AISI 304 livrée sans écrou.

Semelle en caoutchouc NBR vulcanisé. Dureté 80° shore.

Note : Excellent rapport performance/coût.

Semelle extrêmement résistante aux ripages ou déplacements de machines.