

Pied articulé oscillant fixable embase inox diam 100 et tige inox M16 long. 175 charge max 15 000 N



Références du produit

Reference: -

EAN13: -

UPC: -

Description du produit

Pied articulé oscillant fixable. Embase inox diam 100. Tige inox M16 longueur 175, charge max : 15 000 Newton

Caractéristique matière : Embase en inox AISI 304. Tige en inox AISI 304 livrée sans écrou. Semelle en caoutchouc NBR vulcanisé dureté 80° shore.

Info : Facilité de fixation due au grand entraxe tige-oreille. Excellent rapport performance/coût. Réalisation de dimensions et finitions spéciales de tiges filetées dès 100 pièces. Semelle extrêmement résistante aux ripages ou déplacements de machines. Inox 316 sur demande.

Les photos ne sont pas contractuelles.

Pour plus d'informations : contact@binder-jenny.fr ou 03 88 39 21 45

Caractéristiques

Filetage (mm): M16

Hauteur totale (mm): 214,5

Hauteur minimum (mm): 39,5

Résistance (Newton): 15000

Hauteur base : 30

longueur filetage: 175

Diamètre de la base : 100

Images



Embases tôle inox

Ø 100

Embase inox Tige inox Pied articulé oscillant fixeable

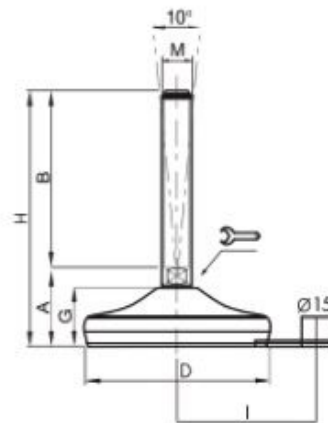

DIMENSIONS								CHARGE MAXI
A	B	D		M	G	H	I	Newton
39,5	75	100	13	M16	30	114,5	69	15 000
39,5	100	100	13	M16	30	139,5	69	15 000
39,5	125	100	13	M16	30	164,5	69	15 000
39,5	150	100	13	M16	30	189,5	69	15 000
39,5	175	100	13	M16	30	214,5	69	15 000
39,5	200	100	13	M16	30	239,5	69	15 000
43	75	100	17	M20	30	118	69	15 000
43	100	100	17	M20	30	143	69	15 000
43	125	100	17	M20	30	168	69	15 000
43	150	100	17	M20	30	193	69	15 000
43	175	100	17	M20	30	218	69	15 000
43	200	100	17	M20	30	243	69	15 000
43	225	100	17	M20	30	268	69	15 000
43	250	100	17	M20	30	293	69	15 000
44	100	100	20	M24	30	144	69	15 000
44	125	100	20	M24	30	169	69	15 000
44	150	100	20	M24	30	194	69	15 000
44	175	100	20	M24	30	219	69	15 000
44	200	100	20	M24	30	244	69	15 000
44	225	100	20	M24	30	269	69	15 000
44	250	100	20	M24	30	294	69	15 000

Matière : Embase en inox AISI 304. Tige en inox AISI 304 livrée sans écrou.

Semelle en caoutchouc NBR vulcanisé dureté 80° shore.

Note : Facilité de fixation due au grand entraxe tige-oreille. Excellent rapport performance/coût.

Semelle extrêmement résistante aux ripages ou déplacements de machines.