

Pied articulé oscillant embase inox diam 80 et tige inox M20 long. 100 charge max 10 000 N



Références du produit

Reference: -

EAN13: -

UPC: -

Description du produit

Pied articulé oscillant. Embase inox diam 80. Tige inox M20 longueur 100, charge max : 10 000 Newton

Caractéristique matière : Embase en inox AISI 304. Tige en inox AISI 304 livrée sans écrou. Semelle en caoutchouc NBR vulcanisé dureté 80° shore.

Info : Excellent rapport performance/coût. Réalisation de dimensions et finitions spéciales de tiges filetées dès 200 pièces. Semelle extrêmement résistante aux ripages ou déplacements de machines. Inox 316 sur demande.

Les photos ne sont pas contractuelles.

Pour plus d'informations : contact@binder-jenny.fr ou 03 88 39 21 45

Caractéristiques

Filetage (mm): M20
Hauteur totale (mm): 138
Hauteur minimum (mm): 38
Résistance (Newton): 10000
Hauteur base : 25
longueur filetage: 100
Diamètre de la base : 80
hauteur sans semelle: 138

Images











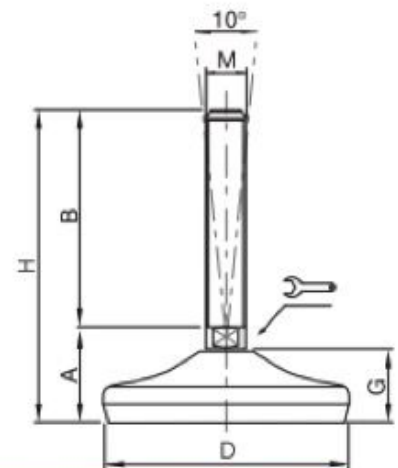







Embases tôle inox

Ø 80

Embase inox Tige inox Pied articulé oscillant

MATIERE Embase en inox AISI 304
Tige en Inox AISI 304
livrée sans écrou.
Semelle en caoutchouc NBR vulcanisé dureté
80° shore.



DIMENSIONS							CHARGE MAXI
A	B	D		M	G	H	Newton
38	75	80	17 	M20	25	113	10 000
38	100	80	17 	M20	25	138	10 000
38	125	80	17 	M20	25	163	10 000
38	150	80	17 	M20	25	188	10 000
38	175	80	17 	M20	25	213	10 000
38	200	80	17 	M20	25	238	10 000
38	225	80	17 	M20	25	260	10 000
40	75	80	20 	M24	25	115	10 000
40	100	80	20 	M24	25	140	10 000
40	125	80	20 	M24	25	165	10 000
40	150	80	20 	M24	25	190	10 000
40	175	80	20 	M24	25	215	10 000
40	200	80	20 	M24	25	240	10 000
40	225	80	20 	M24	25	265	10 000