

Pied articulé oscillant embase inox diam 80 et tige inox M14 long. 175 charge max 10 000 N



Références du produit

Reference: -

EAN13: -

UPC: -

Description du produit

Pied articulé oscillant. Embase inox diam 80. Tige inox M14 longueur 175, charge max : 10 000 Newton

Caractéristique matière : Embase en inox AISI 304. Tige en inox AISI 304 livrée sans écrou. Semelle en caoutchouc NBR vulcanisé dureté 80° shore.

Info : Excellent rapport performance/coût. Réalisation de dimensions et finitions spéciales de tiges filetées dès 200 pièces. Semelle extrêmement résistante aux ripages ou déplacements de machines. Inox 316 sur demande.

Les photos ne sont pas contractuelles.

Pour plus d'informations : contact@binder-jenny.fr ou 03 88 39 21 45

Caractéristiques

Filetage (mm): M14
Hauteur totale (mm): 210
Hauteur minimum (mm): 35
Résistance (Newton): 10000
Hauteur base : 25
longueur filetage: 175
Diamètre de la base : 80

Images











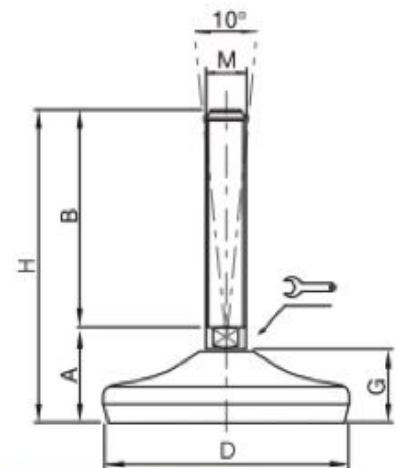









Embases tôle inox

Ø 80

Embase inox Tige inox Pied articulé oscillant

MATIERE Embase en inox AISI 304
Tige en Inox AISI 304
livrée sans écrou.
Semelle en caoutchouc NBR vulcanisé dureté
80° shore.



DIMENSIONS							CHARGE MAXI
A	B	D		M	G	H	Newton
35	75	80	14 	M10	25	110	10 000
35	100	80	14 	M10	25	135	10 000
35	125	80	14 	M10	25	160	10 000
35	75	80	14 	M12	25	110	10 000
35	100	80	14 	M12	25	135	10 000
35	125	80	14 	M12	25	160	10 000
35	150	80	14 	M12	25	185	10 000
35	75	80	14 	M14	25	110	10 000
35	100	80	14 	M14	25	135	10 000
35	125	80	14 	M14	25	160	10 000
35	150	80	14 	M14	25	185	10 000
35	175	80	14 	M14	25	210	10 000
35	75	80	13 	M16	25	110	10 000
35	100	80	13 	M16	25	135	10 000
35	125	80	13 	M16	25	160	10 000
35	150	80	13 	M16	25	185	10 000
35	175	80	13 	M16	25	210	10 000