

Pied articulé oscillant embase acier diam 100 et tige acier M24 long. 100 charge max 15 000 N



Références du produit

Reference: -

EAN13: -

UPC: -

Description du produit

Pied articulé oscillant. Embase acier diam 100. Tige acier M24 longueur 100 charge maximale : 15 000 newton

Caractéristique matière : Embase en acier zingué C40. Tige acier zingué livrée sans écrou. Semelle en caoutchouc NBR vulcanisé dureté 80° shore.

Infos : Excellent rapport performance/coût. Réalisation de dimensions et finitions spéciales de tiges filetées dès 200 pièces. Semelle extrêmement résistante aux ripages ou déplacements de machines.

Les photos ne sont pas contractuelles.

Pour plus d'informations : contact@binder-jenny.fr ou 03 88 39 21 45

Caractéristiques

Filetage (mm): M24

Hauteur totale (mm): 138,5

Hauteur minimum (mm): 38,5

Résistance (Newton): 15000

Hauteur base : 28

longueur filetage: 100

Diamètre de la base : 100

Images









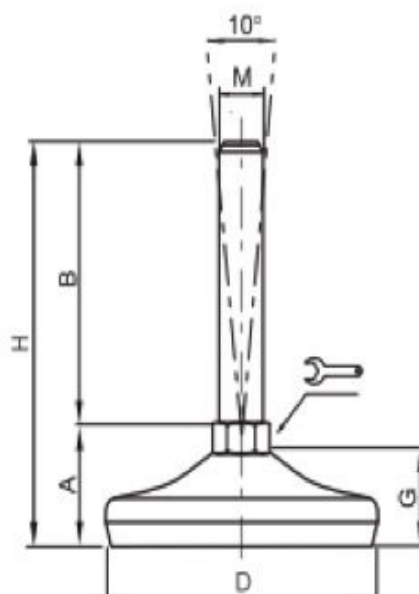











Embases tôle acier

Ø 100

Embase acier Tige acier
Pied articulé oscillant



DIMENSIONS							CHARGE MAXI
A	B	D		M	G	H	Newton
37,5	75	100	16 	M16	28	112,5	15 000
37,5	100	100	16 	M16	28	137,5	15 000
37,5	150	100	16 	M16	28	187,5	15 000
37,5	200	100	16 	M16	28	237,5	15 000
38,5	75	100	20 	M20	28	113,5	15 000
38,5	100	100	20 	M20	28	138,5	15 000
38,5	150	100	20 	M20	28	188,5	15 000
38,5	200	100	20 	M20	28	238,5	15 000
38,5	250	100	20 	M20	28	288,5	15 000
38,5	100	100	24 	M24	28	138,5	15 000
38,5	150	100	24 	M24	28	188,5	15 000
38,5	200	100	24 	M24	28	238,5	15 000
38,5	250	100	24 	M24	28	288,5	15 000
39,5	100	100	30 	M30	28	139,5	15 000
39,5	150	100	30 	M30	28	189,5	15 000
39,5	200	100	30 	M30	28	239,5	15 000
39,5	250	100	30 	M30	28	289,5	15 000

Matière : Embase en acier zingué C40. Tige en acier zingué livrée sans écrou.
Semelle en caoutchouc NBR vulcanisé dureté 80° shore.

Note : Excellent rapport performance/coût. Semelle extrêmement résistance aux ripages ou déplacements de machine.