

Pied articulé oscillant embase acier diam 80 et tige acier M20 long. 75 charge max 10 000 N



Références du produit

Reference: -

EAN13: -

UPC: -

Description du produit

Pied articulé oscillant. Embase acier diam 80. Tige acier M20 longueur 75 charge maximale : 10 000 newton

Caractéristique matière : Embase en acier zingué C40. Tige acier zingué livrée sans écrou. Semelle en caoutchouc NBR vulcanisé dureté 80° shore.

Infos : Excellent rapport performance/coût. Réalisation de dimensions et finitions spéciales de tiges filetées dès 200 pièces. Semelle extrêmement résistante aux ripages ou déplacements de machines.

Les photos ne sont pas contractuelles.

Pour plus d'informations : contact@binder-jenny.fr ou 03 88 39 21 45



Caractéristiques

Filetage (mm): M20

Hauteur totale (mm): 111

Hauteur minimum (mm): 36

Résistance (Newton): 10000

Hauteur base : 25

longueur filetage: 75

Diamètre de la base : 80

Images





Embases tôle acier

Ø 80

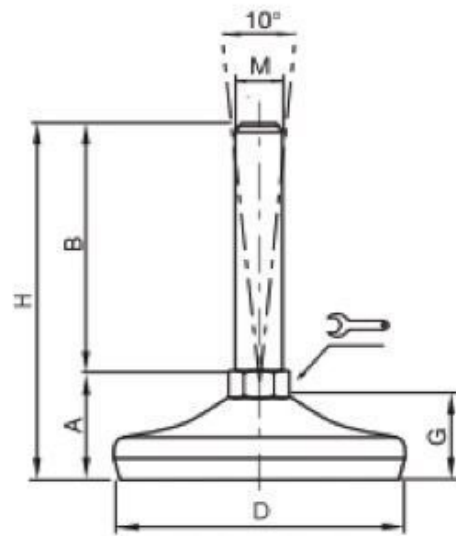
Embase acier Tige acier
Pied articulé oscillant



| DIMENSIONS | | | | | | | CHARGE MAXI |
|------------|-----|----|--|-----|----|-----|-------------|
| A | B | D |  | M | G | H | Newton |
| 35 | 50 | 80 | 14  | M10 | 25 | 85 | 10 000 |
| 35 | 100 | 80 | 14  | M10 | 25 | 135 | 10 000 |
| 35 | 50 | 80 | 14  | M12 | 25 | 85 | 10 000 |
| 35 | 100 | 80 | 14  | M12 | 25 | 135 | 10 000 |
| 35 | 150 | 80 | 14  | M12 | 25 | 185 | 10 000 |
| 35 | 50 | 80 | 14  | M14 | 25 | 110 | 10 000 |
| 35 | 100 | 80 | 14  | M14 | 25 | 135 | 10 000 |
| 35 | 150 | 80 | 14  | M14 | 25 | 185 | 10 000 |
| 35 | 75 | 80 | 16  | M16 | 25 | 110 | 10 000 |
| 35 | 100 | 80 | 16  | M16 | 25 | 135 | 10 000 |
| 35 | 150 | 80 | 16  | M16 | 25 | 185 | 10 000 |
| 36 | 75 | 80 | 20  | M20 | 25 | 111 | 10 000 |
| 36 | 100 | 80 | 20  | M20 | 25 | 136 | 10 000 |
| 36 | 150 | 80 | 20  | M20 | 25 | 186 | 10 000 |
| 36 | 200 | 80 | 20  | M20 | 25 | 236 | 10 000 |
| 36 | 75 | 80 | 24  | M24 | 25 | 111 | 10 000 |
| 36 | 100 | 80 | 24  | M24 | 25 | 136 | 10 000 |
| 36 | 150 | 80 | 24  | M24 | 25 | 186 | 10 000 |
| 36 | 200 | 80 | 24  | M24 | 25 | 236 | 10 000 |

Matière : Embase en acier zingué C40. Tige en acier zingué livrée sans écrou.
Semelle en caoutchouc NBR vulcanisé dureté 80° shore.

Note : Excellent rapport performance/coût.

Semelle extrêmement résistance aux ripages ou déplacements de machines.