

# Pied articulé oscillant embase acier diam 80 et tige acier M10 long. 100 charge max 10 000 N



## Références du produit

Reference: -

EAN13: -

UPC: -

## Description du produit

**Pied articulé oscillant. Embase acier diam 80. Tige acier M10 longueur 100 charge maximale : 10 000 newton**

**Caractéristique matière :** Embase en acier zingué C40. Tige acier zingué livrée sans écrou. Semelle en caoutchouc NBR vulcanisé dureté 80° shore.

**Infos :** Excellent rapport performance/coût. Réalisation de dimensions et finitions spéciales de tiges filetées dès 200 pièces. Semelle extrêmement résistante aux ripages ou déplacements de machines.

Les photos ne sont pas contractuelles.

Pour plus d'informations : [contact@binder-jenny.fr](mailto:contact@binder-jenny.fr) ou 03 88 39 21 45



## Caractéristiques

Filetage (mm): M10

Hauteur totale (mm): 135

Hauteur minimum (mm): 35

Résistance (Newton): 10000

Hauteur base : 25

longueur filetage: 100

Diamètre de la base : 80

## Images









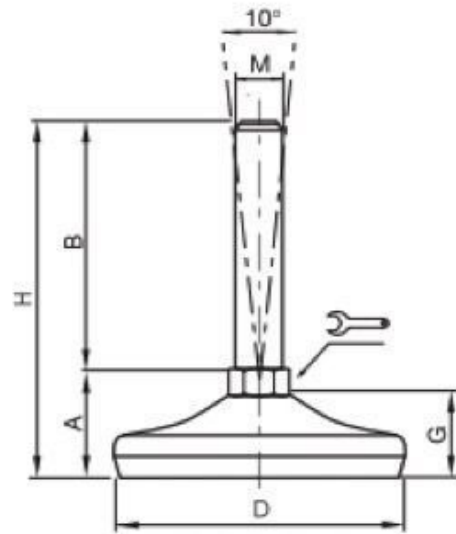











## Embases tôle acier

Ø 80

Embase acier Tige acier  
Pied articulé oscillant



DIMENSIONS							CHARGE MAXI
A	B	D		M	G	H	Newton
35	50	80	14 	M10	25	85	10 000
35	100	80	14 	M10	25	135	10 000
35	50	80	14 	M12	25	85	10 000
35	100	80	14 	M12	25	135	10 000
35	150	80	14 	M12	25	185	10 000
35	50	80	14 	M14	25	110	10 000
35	100	80	14 	M14	25	135	10 000
35	150	80	14 	M14	25	185	10 000
35	75	80	16 	M16	25	110	10 000
35	100	80	16 	M16	25	135	10 000
35	150	80	16 	M16	25	185	10 000
36	75	80	20 	M20	25	111	10 000
36	100	80	20 	M20	25	136	10 000
36	150	80	20 	M20	25	186	10 000
36	200	80	20 	M20	25	236	10 000
36	75	80	24 	M24	25	111	10 000
36	100	80	24 	M24	25	136	10 000
36	150	80	24 	M24	25	186	10 000
36	200	80	24 	M24	25	236	10 000

**Matière :** Embase en acier zingué C40. Tige en acier zingué livrée sans écrou.  
Semelle en caoutchouc NBR vulcanisé dureté 80° shore.

**Note :** Excellent rapport performance/coût.  
Semelle extrêmement résistance aux ripages ou déplacements de machines.