

Pied articulé oscillant fixable embase diam 85 et tige acier M20 long. 200 charge max 15 000 N



Références du produit

Reference: -

EAN13: -

UPC: -

Description du produit

Pied articulé oscillant fixable. Embase acier diam 85. Tige acier M20 longueur 200 charge maximale : 15 000 newton

Caractéristique matière : Embase en acier zingué. Tige acier zingué livrée sans écrou.

Les photos ne sont pas contractuelles.

Pour plus d'informations : contact@binder-jenny.fr ou 03 88 39 21 45

Caractéristiques

Filetage (mm): M20

Hauteur totale (mm): 225

Résistance (Newton): 15000

Hauteur base : 13



longueur filetage: 200
Diamètre de la base : 85
Epaisseur de la base : 3

Images

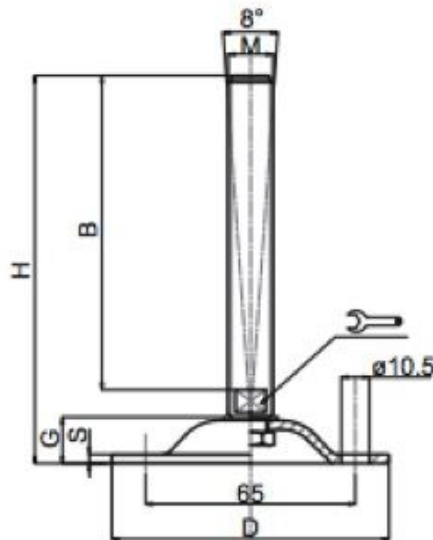

Embases tôle acier

ø 85

 Embase acier Tige acier
 Pied articulé oscillant fixeable

MATIERE

 Embase en acier zingué.
 Tige en acier zingué livrée sans écrou.
 Semelle en caoutchouc NBR vulcanisé dureté
 80° shore.

DIMENSIONS							CHARGE MAXI
S	B	D		M	G	H	Newton
3	100	85	13	M16	13	125	15 000
3	150	85	13	M16	13	175	15 000
3	175	85	13	M16	13	200	15 000
3	100	85	17	M20	13	125	15 000
3	150	85	17	M20	13	175	15 000
3	200	85	17	M20	13	225	15 000