

# Pied articulé oscillant fixable embase diam 85 et tige acier M16 long. 150 charge max 15 000 N



## Références du produit

Reference: -

EAN13: -

UPC: -

## Description du produit

**Pied articulé oscillant fixable. Embase acier diam 85. Tige acier M16 longueur 150 charge maximale : 15 000 newton**

**Caractéristique matière :** Embase en acier zingué. Tige acier zingué livrée sans écrou.

Les photos ne sont pas contractuelles.

Pour plus d'informations : [contact@binder-jenny.fr](mailto:contact@binder-jenny.fr) ou 03 88 39 21 45

## Caractéristiques

Filetage (mm): M16

Hauteur totale (mm): 175

Résistance (Newton): 15000

Hauteur base : 13



longueur filetage: 150  
Diamètre de la base : 85  
Epaisseur de la base : 3

## Images

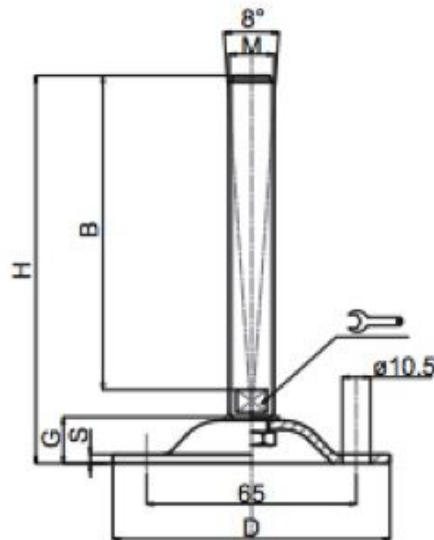







Embases tôle acier

ø 85

Embase acier Tige acier  
Pied articulé oscillant fixable

**MATIERE**

Embase en acier zingué.  
Tige en acier zingué livrée sans écrou.  
Semelle en caoutchouc NBR vulcanisé dureté  
80° shore.

DIMENSIONS							CHARGE MAXI
S	B	D		M	G	H	Newton
3	100	85	13 	M16	13	125	15 000
3	150	85	13 	M16	13	175	15 000
3	175	85	13 	M16	13	200	15 000
3	100	85	17 	M20	13	125	15 000
3	150	85	17 	M20	13	175	15 000
3	200	85	17 	M20	13	225	15 000