

Equilibreur de charges de 3 a 6 kg , filin en acier de 2,20 m , carter PVC



Références du produit

Reference: -

EAN13: -

UPC: -

Description du produit

Caractéristiques

Longueur (m): 2,2

Matiere: acier

CMU (kg): 3-6

Images



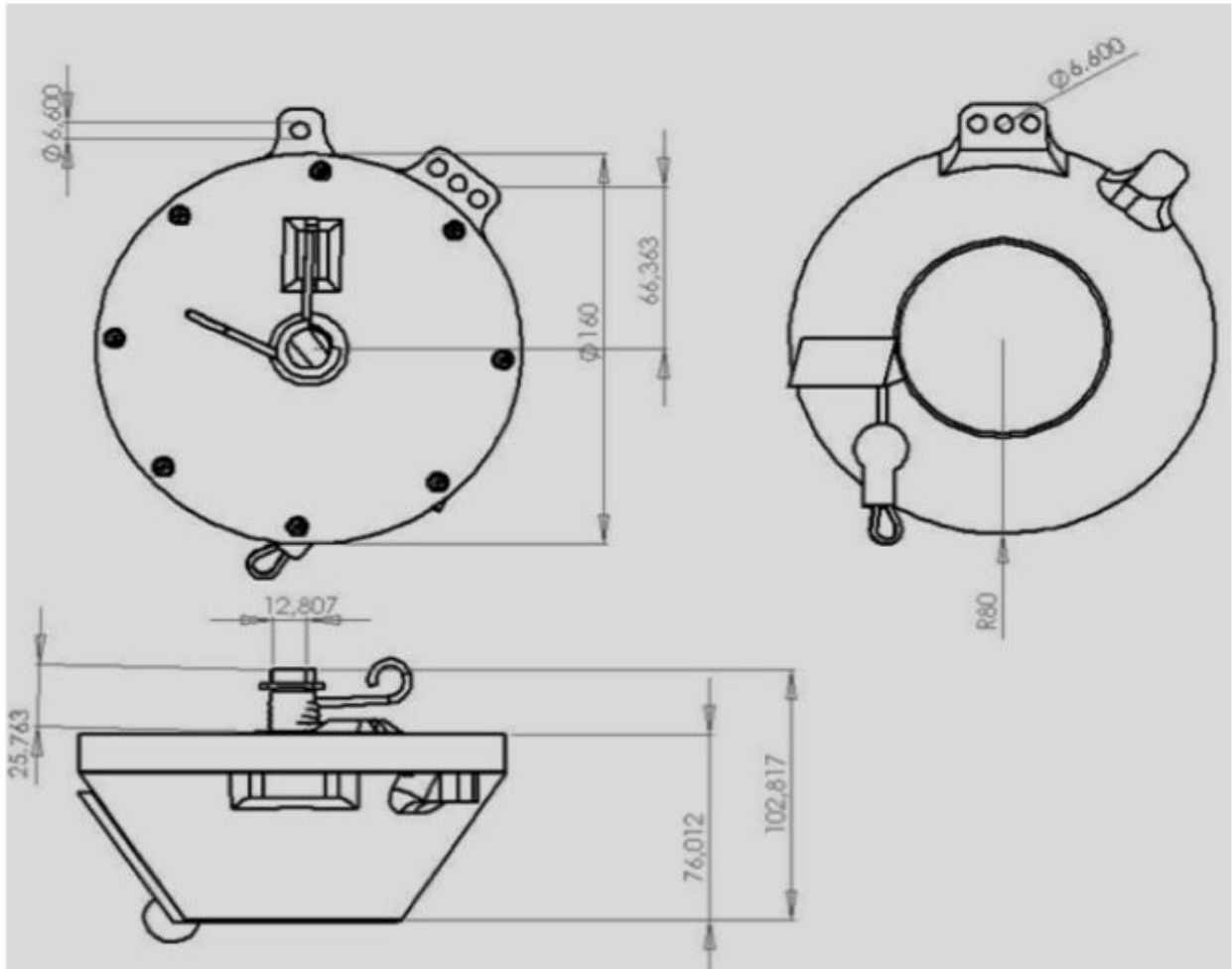

Course/m	Force/kg	Filin	Carter	Tambour	Poids/kg
2,20	3/6	Acier	PVC	Cylindre traction progressive	1,4